

A

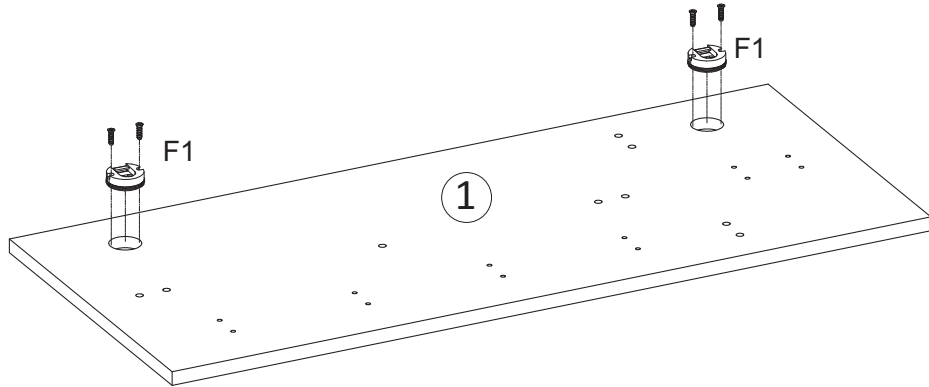

B

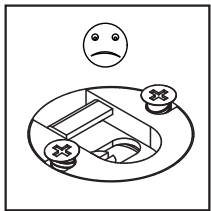
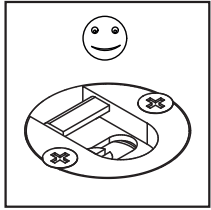
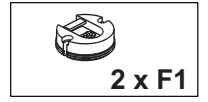
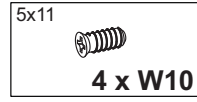
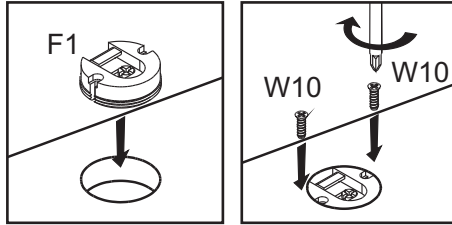
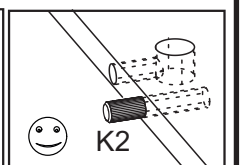
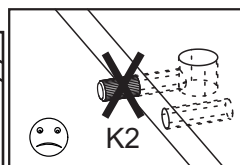
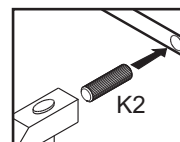
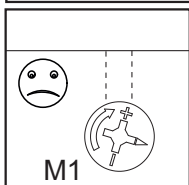
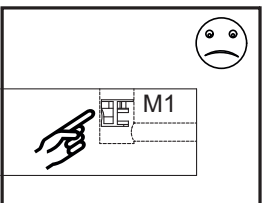
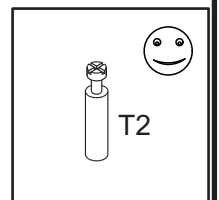
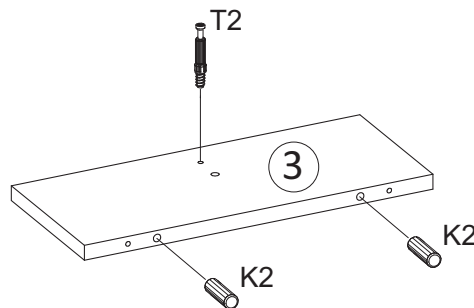
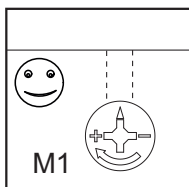
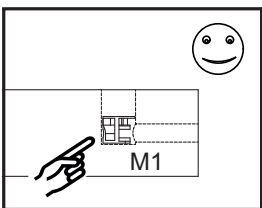
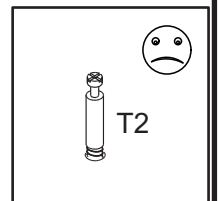
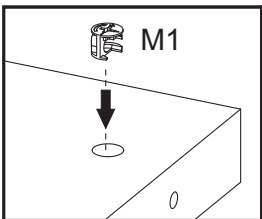
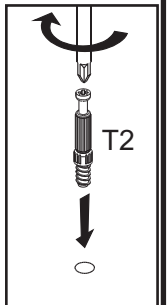
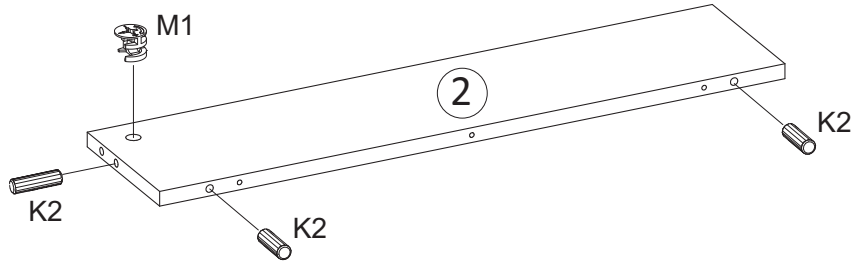
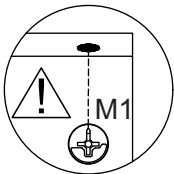
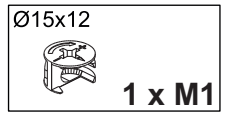
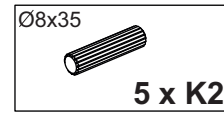
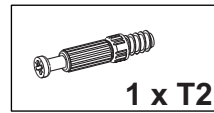

C

Ø20



1 x ZMN

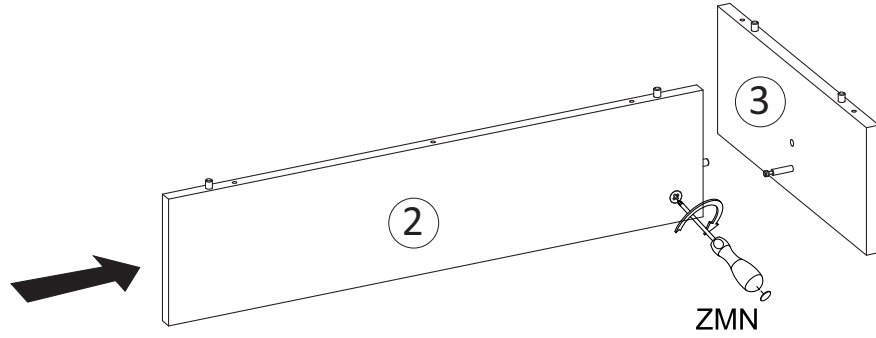
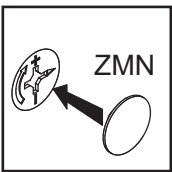
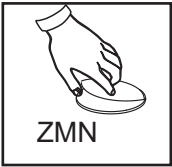
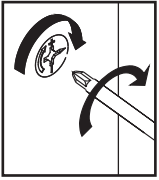
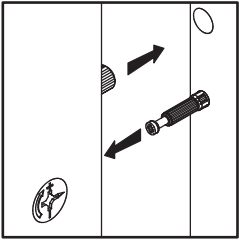

D

Ø7x50



5 x A1

hex 4



1 x I

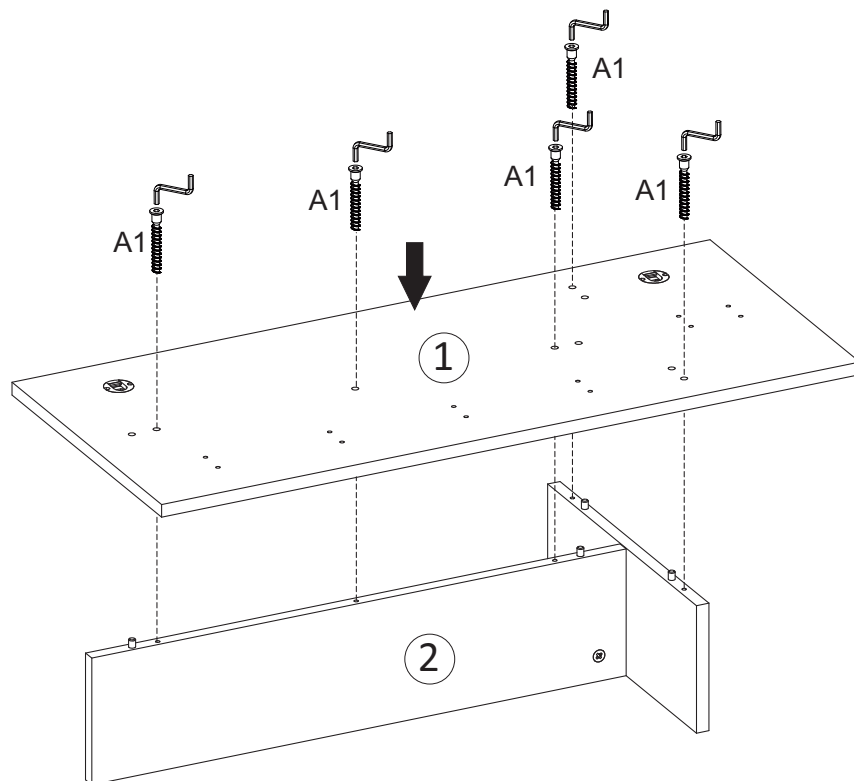
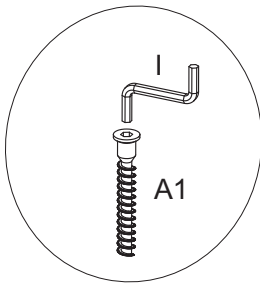

E

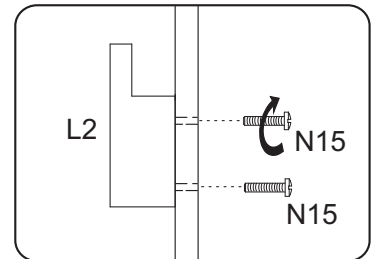
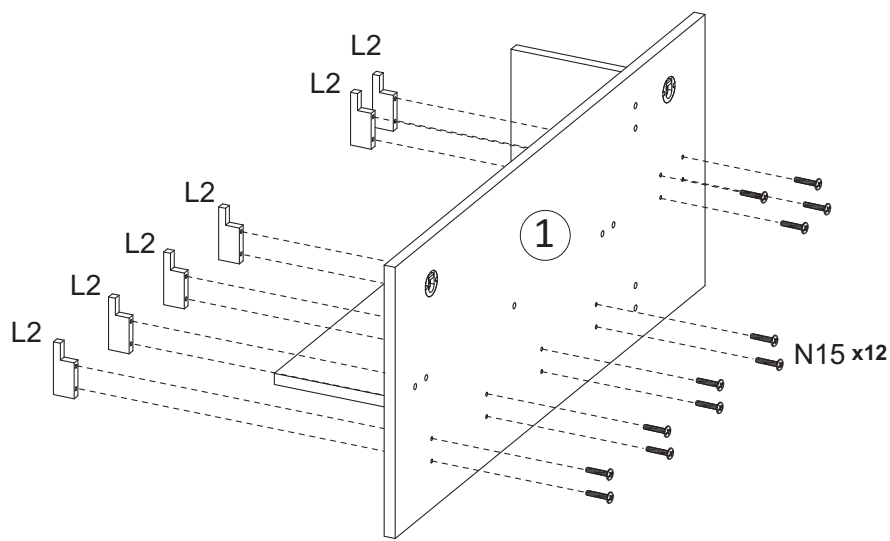
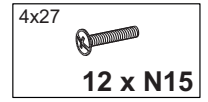
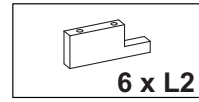

F

